



PelliniNautica





PelliniNautica

Indice dei prodotti/Product index



Rullo/Roller	4.
Plissé/Pleated	8.
Plissé Black-out/Pleated Black-out	10.
Plissé Black-out Frame/Pleated Black-out Frame	11.
Veneziana/Venetian	12.
Lisage	14.
Pacchetto/Soft-shade	15.
Prodotti Custom/Custom Products	16.
Sezione tecnica/Technical section	18.
Tessuti/Fabrics	28.

pelliniindustrie 

PelliniNautica







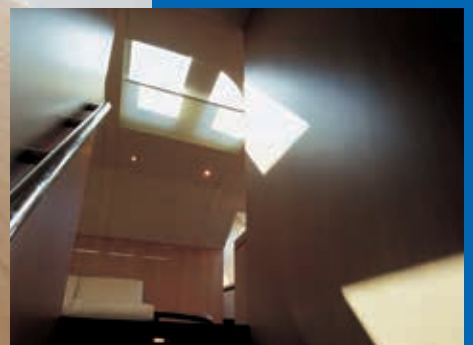







Plissé Black-out/Pleated Black-out



Plissé Black-out Frame/Pleated Black-out Frame







pelliniindustrie







pelliniindustrie





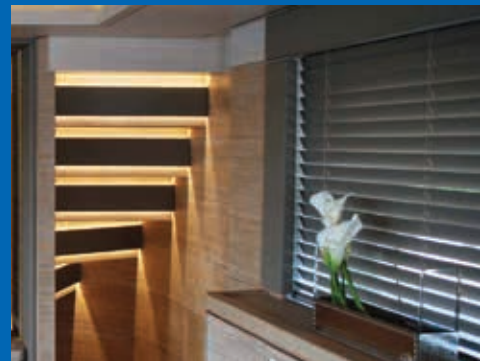
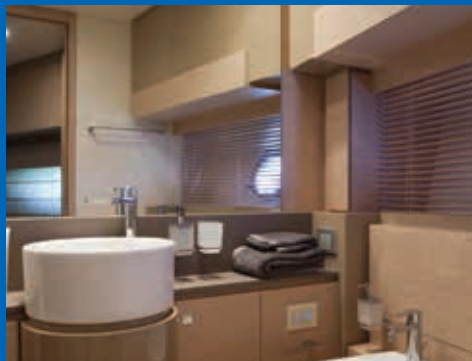
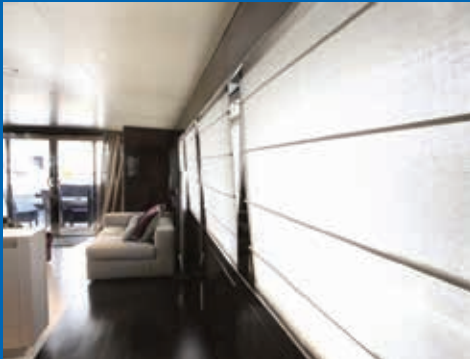

UA16-25 • UA16-25 Venetian blind

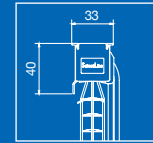
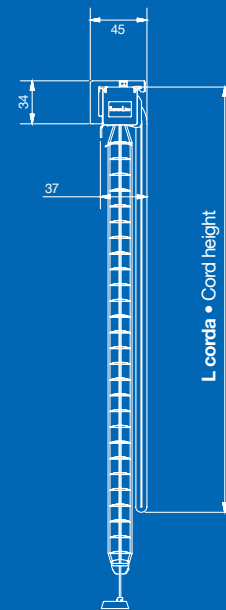
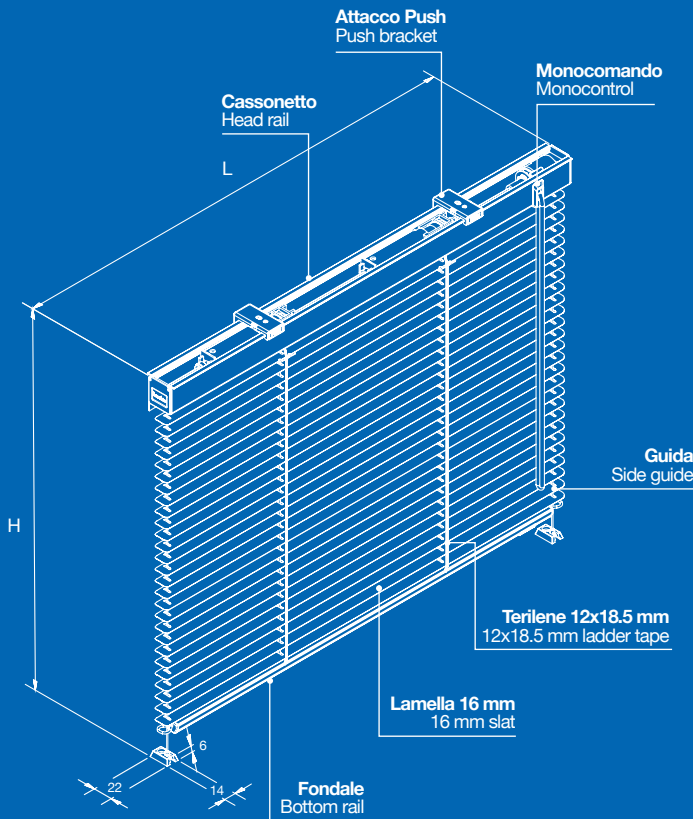

Dimensioni cassonetto
Head rail dimensions

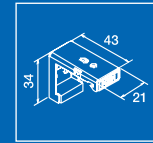

Attacco Push
Push bracket

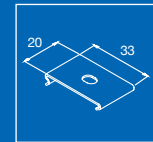

Attacco a scomparsa
Hidden bracket

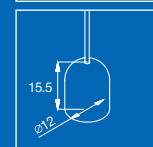

Fermaguida
Side guide tensioner

Optional

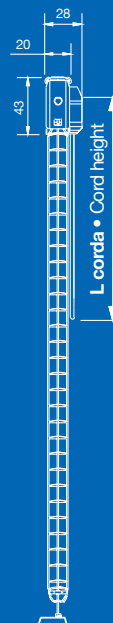
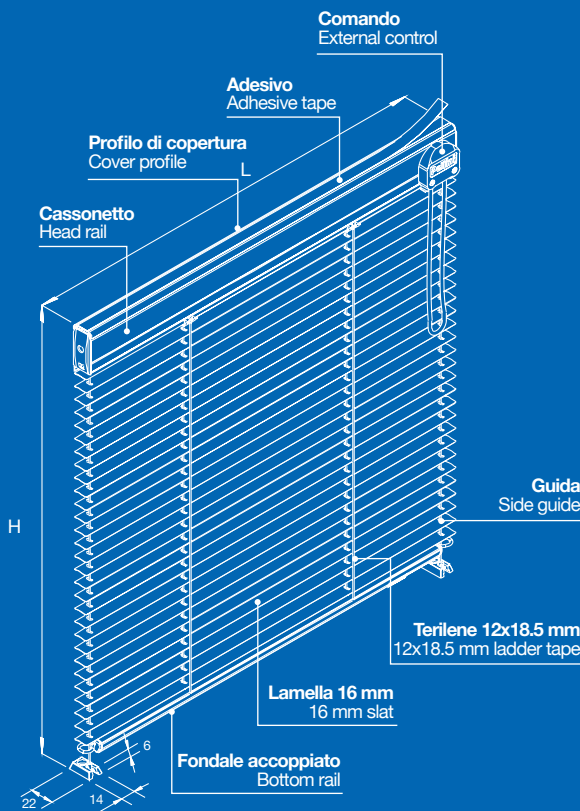

UM16 • UM16 Venetian blind

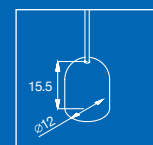

Fermaguida
Side guide tensioner

Optional

Sezione tecnica/Technical section

UA25 legno • UA25 wooden Venetian blind

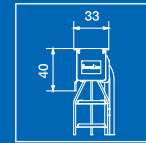
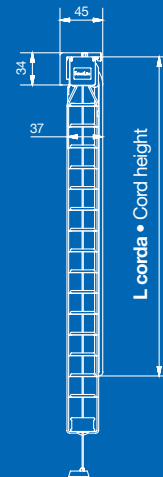
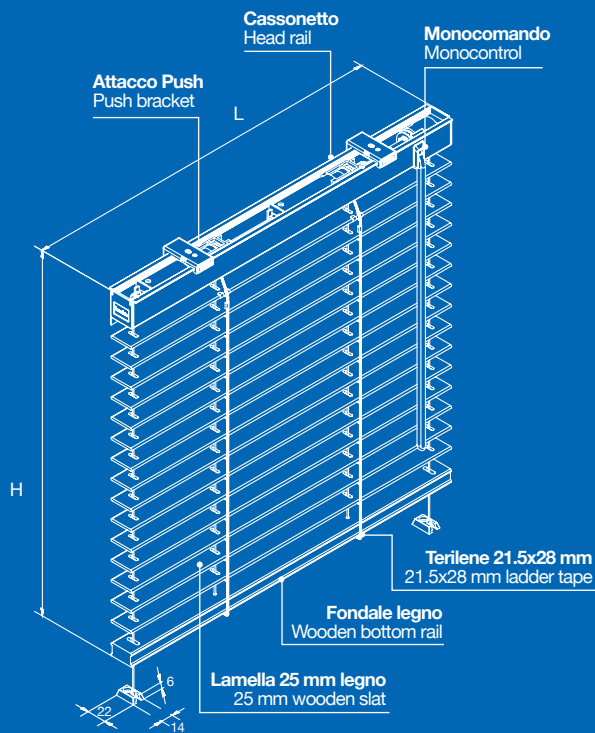

Dimensioni cassonetto
Head rail dimensions

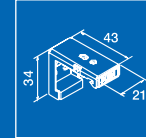

Attacco Push
Push bracket

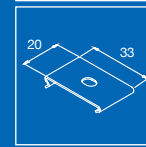

Attacco a
scomparsa
Hidden bracket

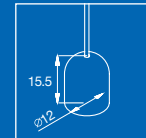

Fermaguida
Side guide tensioner

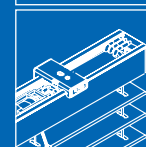

Motore interno 24V
24V internal motor

Optional

Legno 50 mm • 50 mm wooden Venetian blind

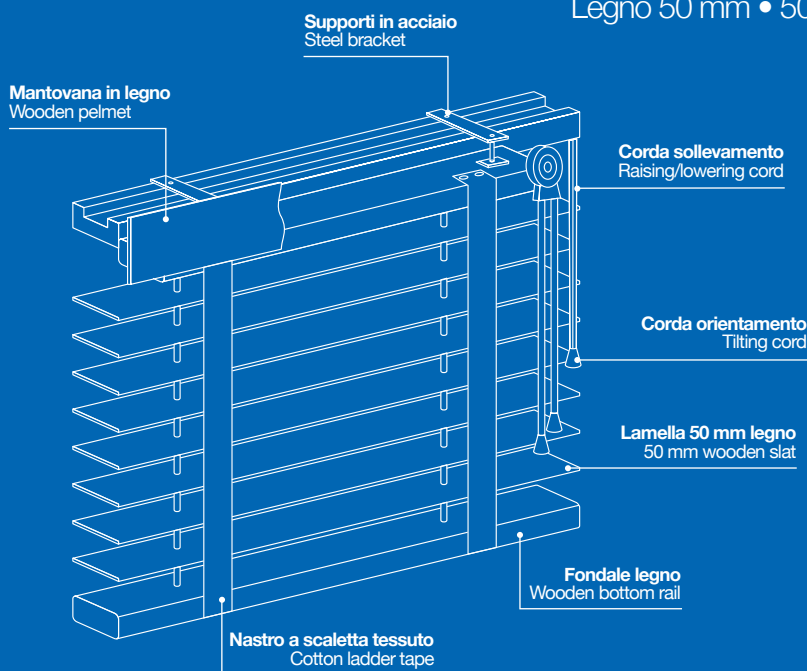

Motorizzazione e accessori a richiesta
On request: motorizations and accessories

UP14 Plissé • UP14 Pleated blind

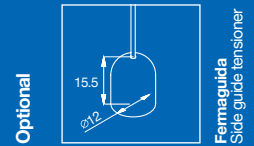
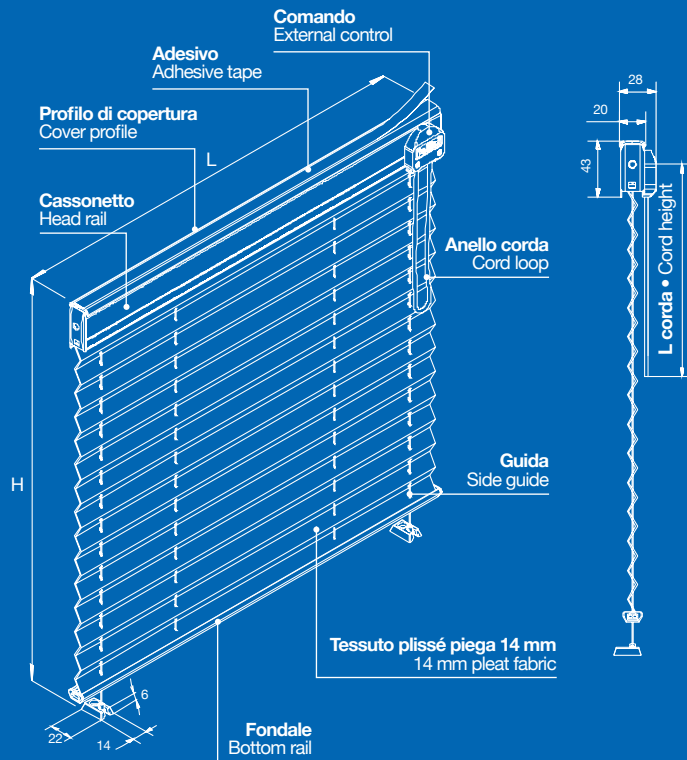

US14 Plissé • US14 Pleated blind

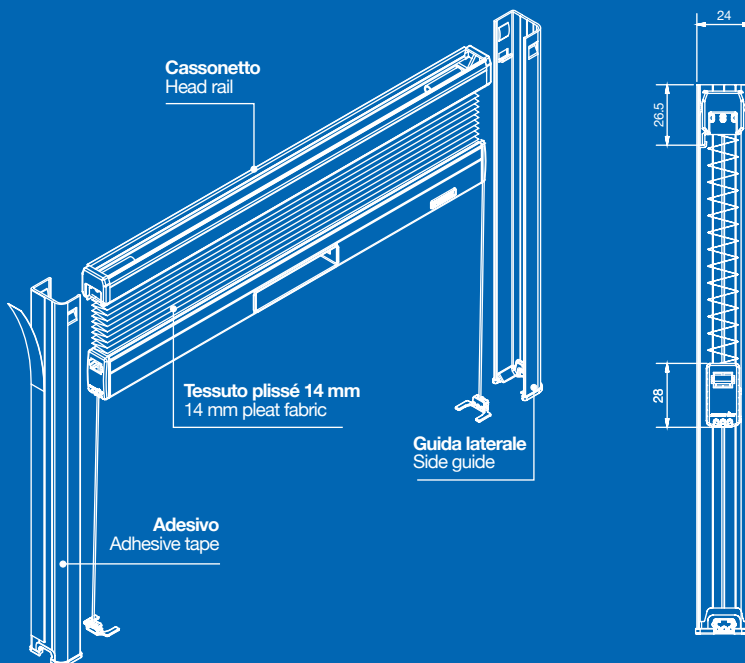

Sezione tecnica/Technical section

UP20 Plissé • UP20 Pleated blind

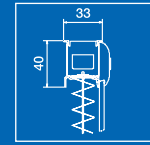
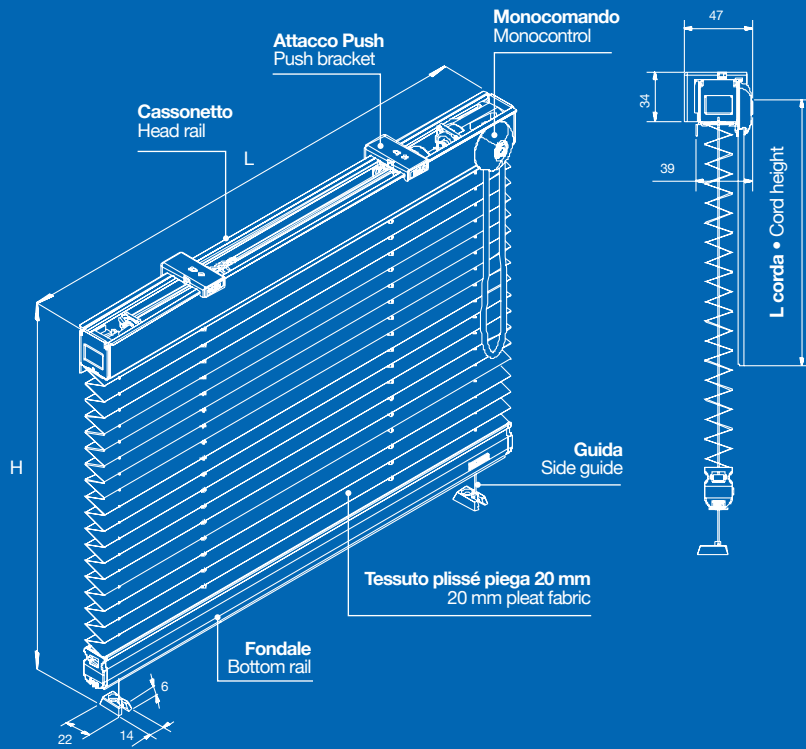

Dimensioni cassonetto
Head rail dimensions

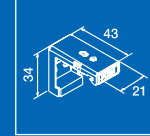

Attacco Push
Push bracket

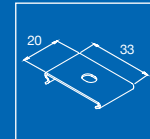

Attacco a scomparsa
Hidden bracket

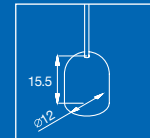

Fermaguida
Side guide tensioner

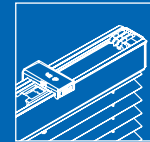

Motore interno 24V
24V internal motor

Optional

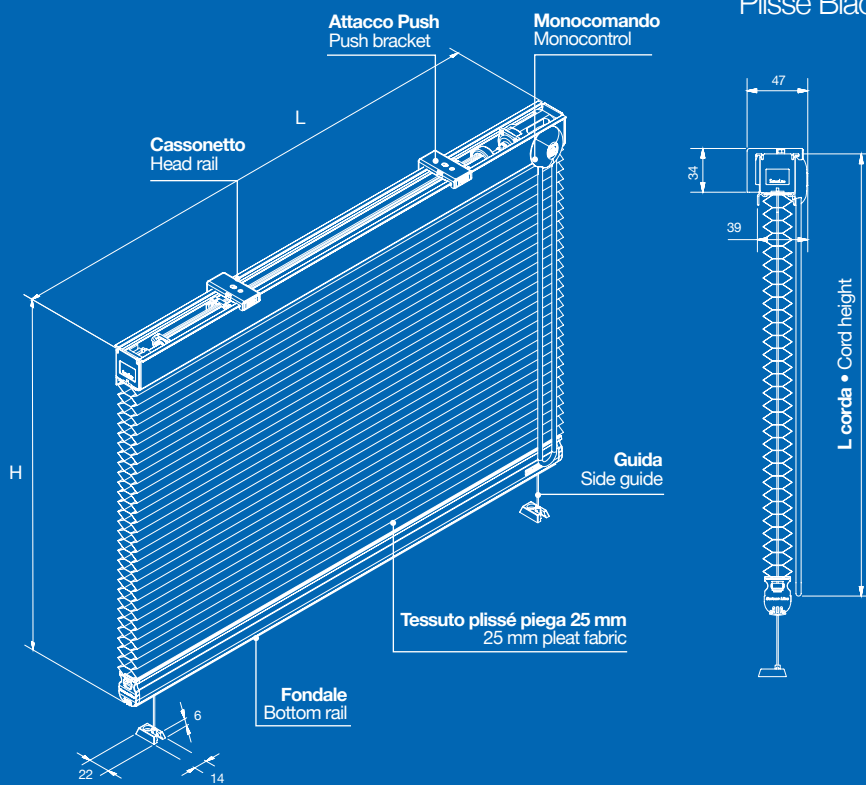

Plissé Black-out • Pleated Black-out

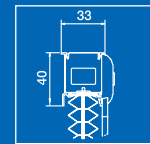

Dimensioni cassonetto
Head rail dimensions

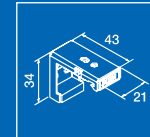

Attacco Push
Push bracket

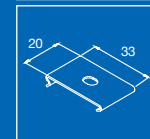

Attacco a scomparsa
Hidden bracket

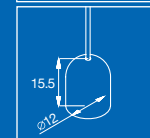

Fermaguida
Side guide tensioner

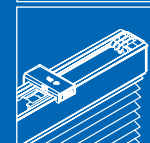

Motore interno 24V
24V internal motor

Optional

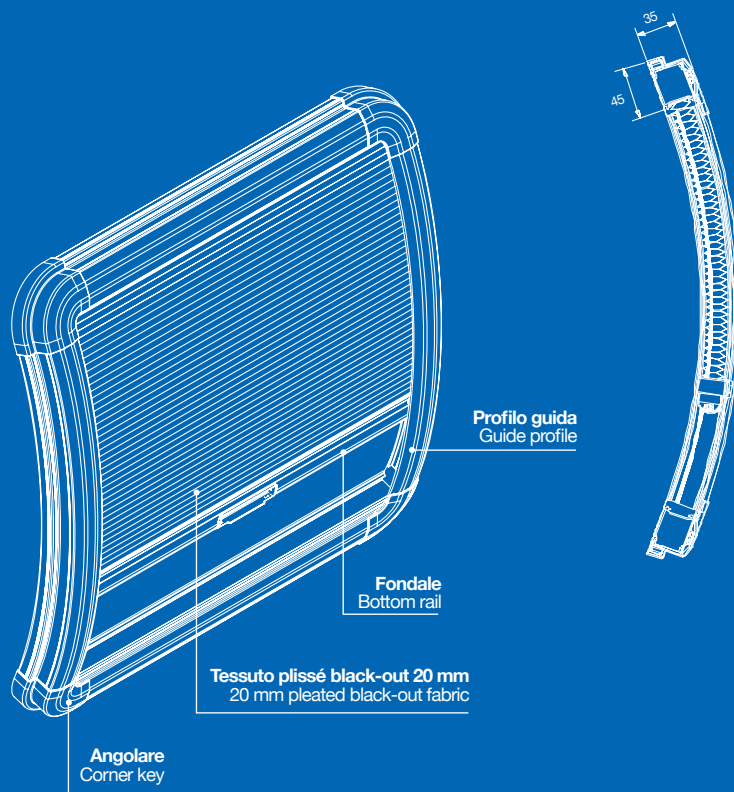

Per motorizzazioni e accessori richiedere fattibilità
Ask feasibility for motorizations and accessories requirement

Sezione tecnica/Technical section

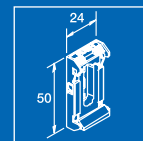
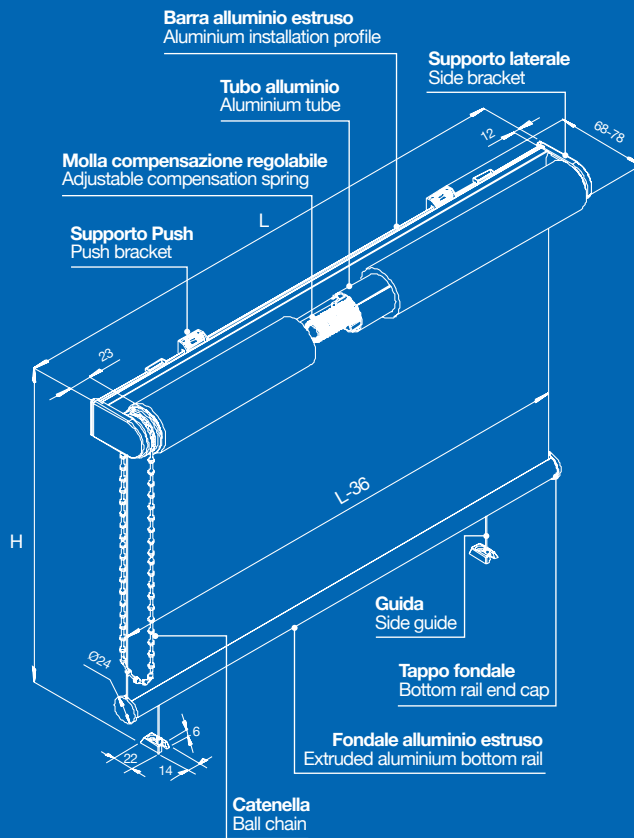

Supporto Push
Push bracket

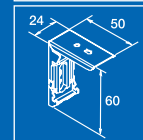

Supporto
Bracket

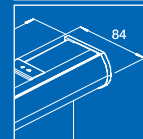

Mantovana
Pelmet

Optional

Molla

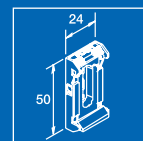
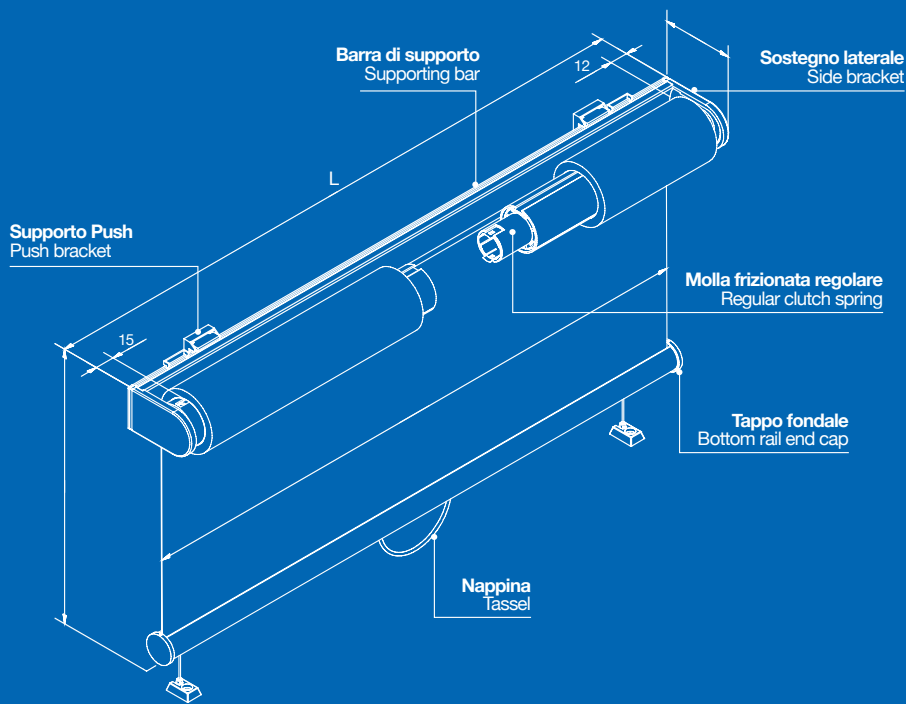

Supporto Push
Push bracket

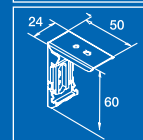

Supporto
Support

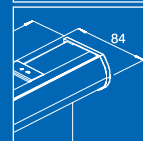

Mantovana
Pelmet

Optional

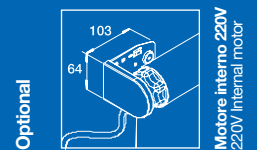
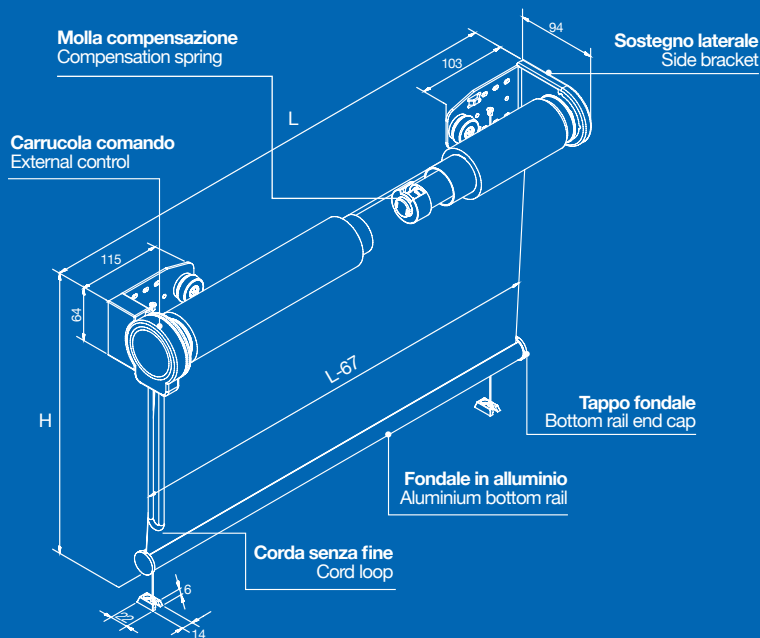
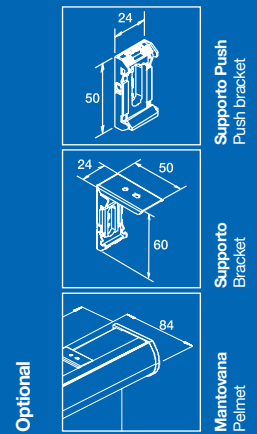
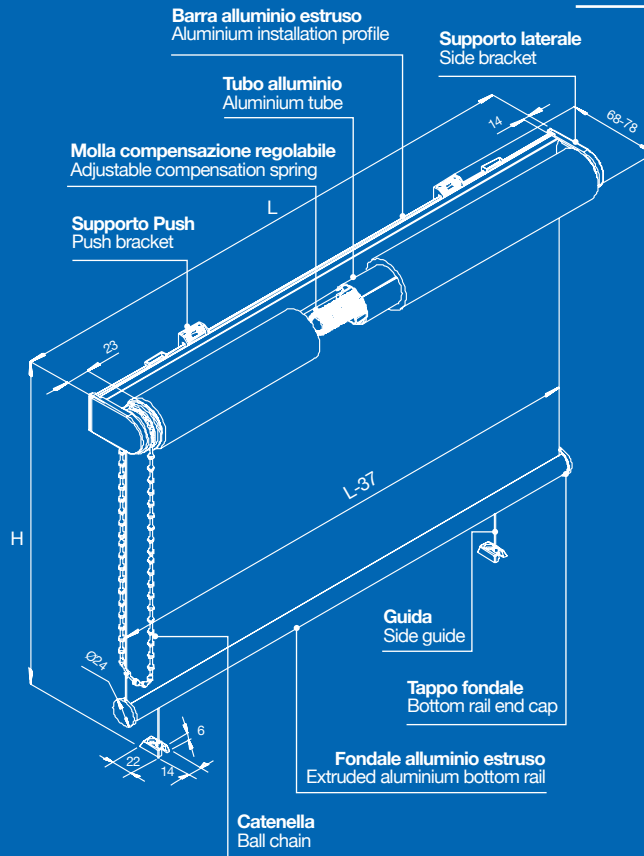

Sezione tecnica/Technical section

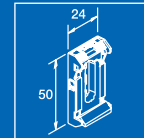
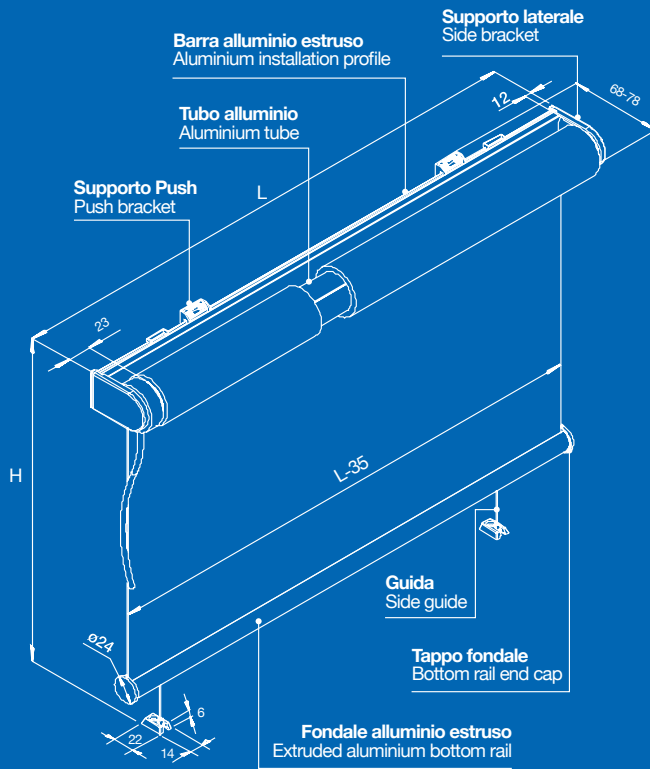

Supporto Push
Push bracket

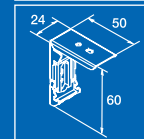

Supporto
Bracket

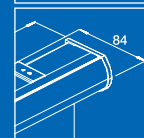

Mantovana
Pelmet

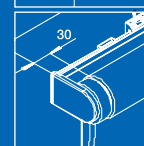

Motore interno 220V
220V internal motor

Optional

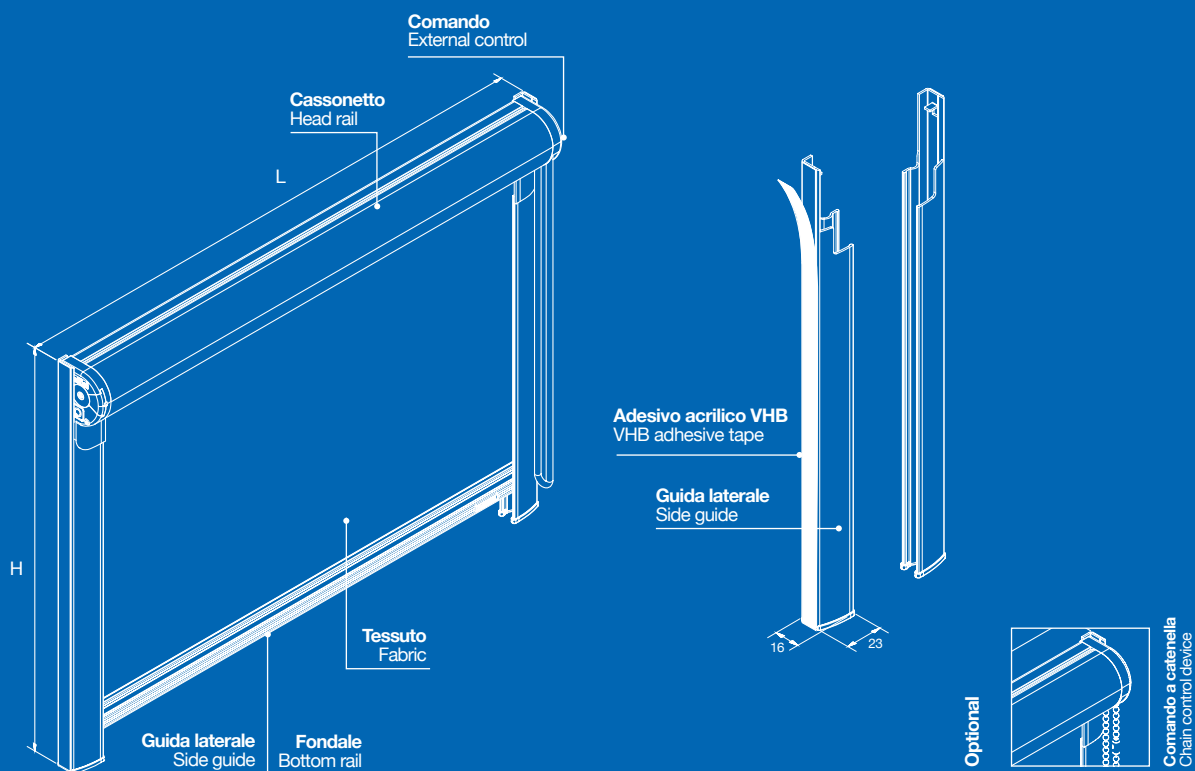

Sezione tecnica/Technical section

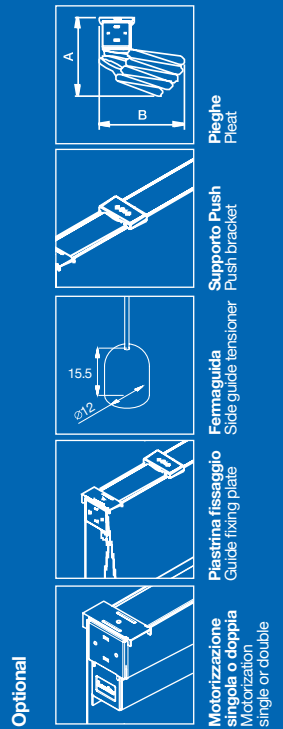
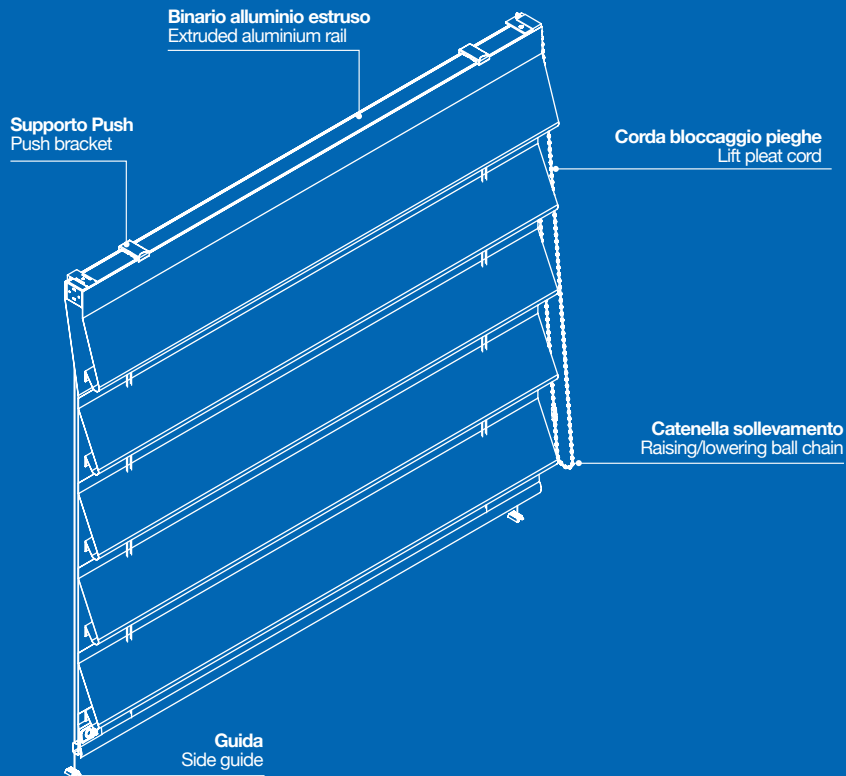

dimensioni • dimensions

Pieghe • Pleats 16 cm

Larghezza • Width cm 50 ~ 190

Altezza • Height cm 10 ~ 300

Ingombri • Overall dimensions cm B 27; A 35

Pieghe • Pleats 24 cm

Larghezza • Width cm 50 ~ 300

Altezza • Height cm 10 ~ 300

Ingombri • Overall dimensions cm B 25; A 43

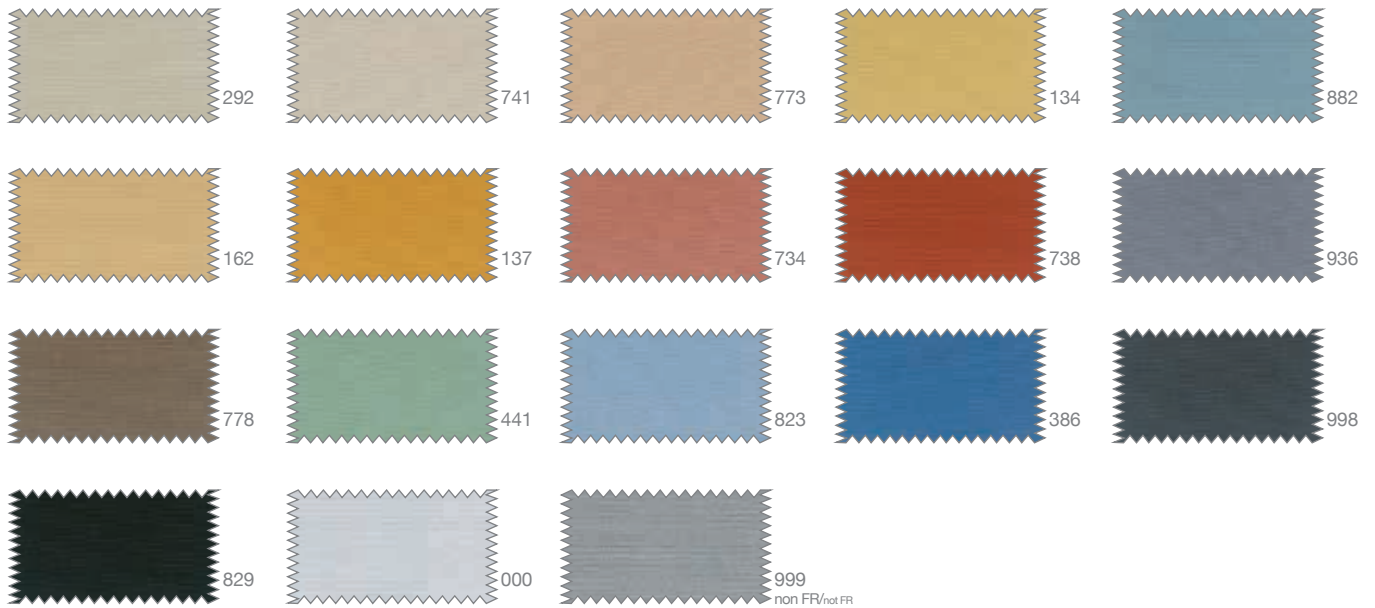

Qualità Verosol®/Verosol Quality

816 FR
Trasparente • Transparent



812 FR
Semi trasparente • Semi transparent



878 FR
Opaco • Opaque



982
Oscurante 100% • Black-out 100%



SilverScreen

2% OF



4% OF

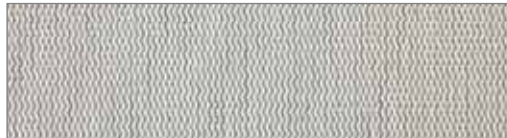

Trasparente • Transparent



EnviroScreen G2



802 G2



805 G2



Rullo PVC



IOS Bianco • White



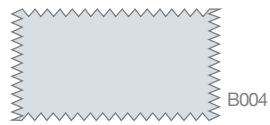

Trevira CS

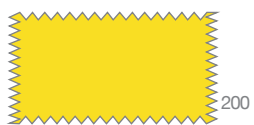
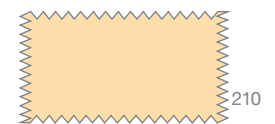
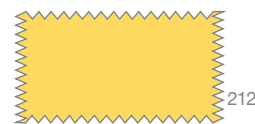
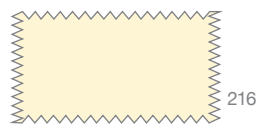
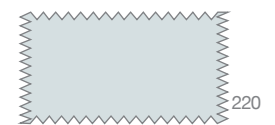
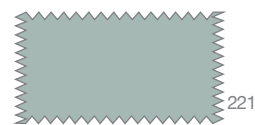
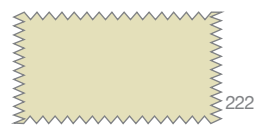
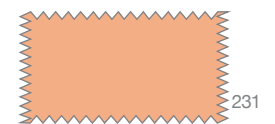
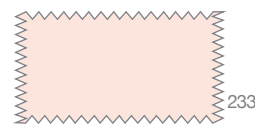
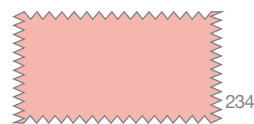
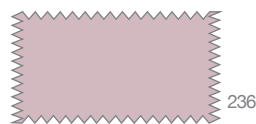
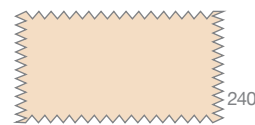
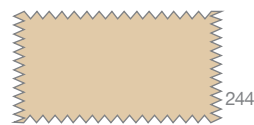
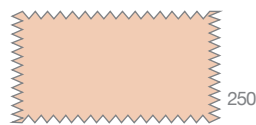
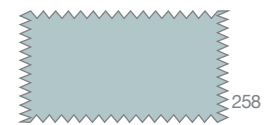
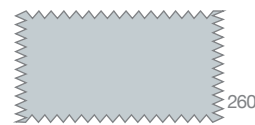
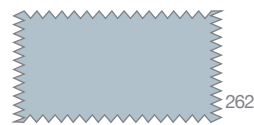
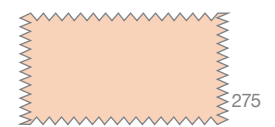
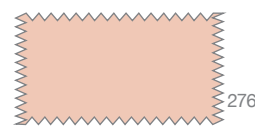
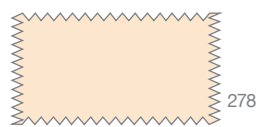
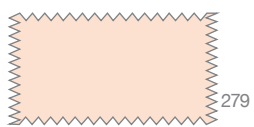

Plissé Black-out



Piega da 20 mm • 20 mm pleat

S102



S149

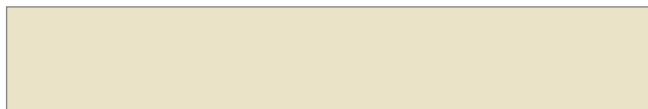

Piega da 25 mm • 25 mm pleat

S102



S149

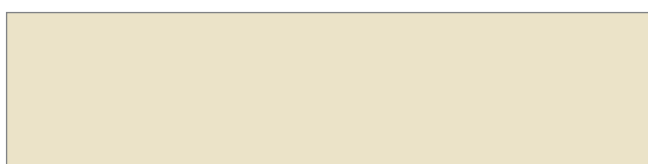

Plissé Vanity



C000
bianco • white



C010
crema • cream

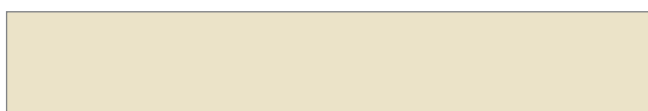

Rullo Light Black-out



grigio • grey

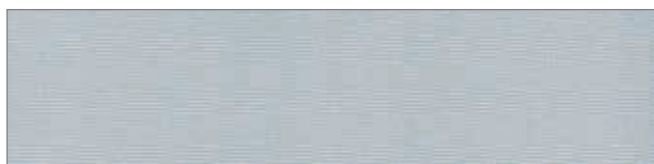

nero • black





Lamelle legno • Wooden slats

Colori standard • Standard colours



Colori custom • Custom colours

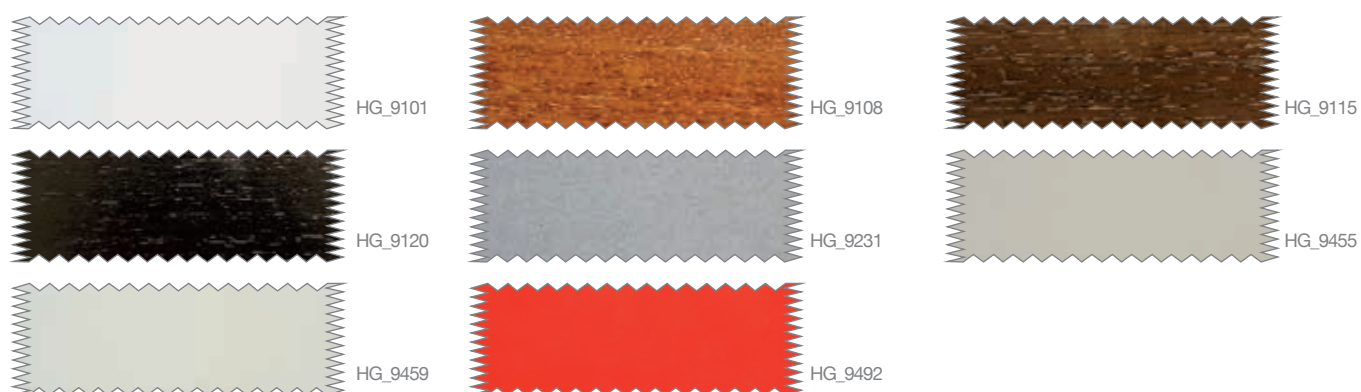

Veneziane in pelle • Leather venetian blinds

Colori pelle ed ecopelle • Leather and imitation leather colours

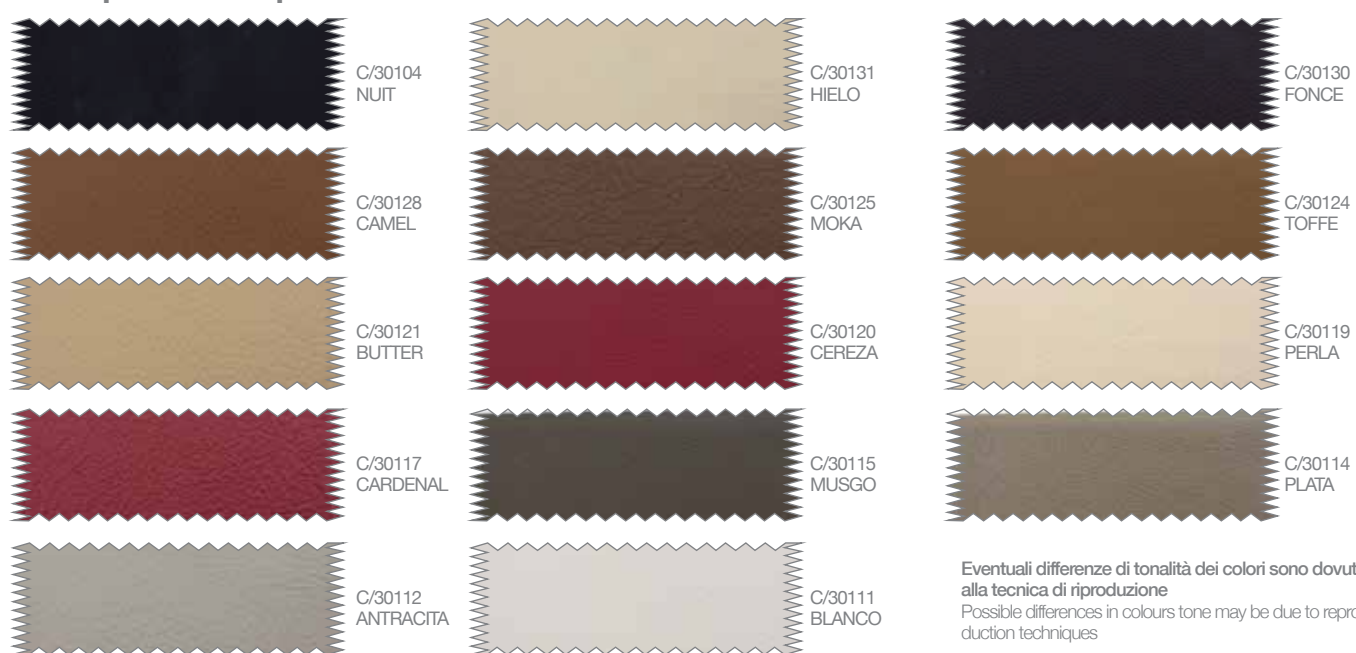



ISO 9001: 2008 Certification • Certificato No. 2351/2

Printed in Italy, 10-2015
BF 1.0



pellinindustrie   

PelliniNautica **Pellini** TENDE E SISTEMI ScreenLine®

A brand of
pellinindustrie
www.pellini.net

Pellini S.p.A. - 26845 Codogno (LO) ITALY • via Fusari, 19 • Ph. +39 0377 466411 • F. +39 0377 466400 • info@pellini.net

ScreenLine Benelux | ScreenLine BR | ScreenLine CZ | ScreenLine France | ScreenLine GmbH | ScreenLine Nordic | ScreenLine UK | ScreenLine Africa | ScreenLine India | ScreenLine Ibérica